

Uchwyty spawalnicze TIG



SPIS TREŚCI

Informacje zamówieniowe

Chłodzone gazem	4 ... 5
Chłodzone cieczą	6 ... 8
Modele z mikrowyłącznikiem łopatkowym	9

Części zamienne i szybkozużywające się

TBi SR 9, TBi SR 20, TBi SR 21	10 ... 11
TBi SR 17, TBi SR 18, TBi SR 26	12 ... 13
TBi SR 24G, TBi SR 24W	14
TBi SR 25G FX, TBi SR 25W FX	15
TBi AW 424, TBi AW 427	16
TBi SR 400	17
TBi XCT 400W	18
TBi SR 12	20

Rękojeści i moduły

Rękojeść Precision	19
Rękojeści tubowe I mikrowyłączniki	21
Rekojeści tubowe do korpusów uchwytów z zaworkiem	22

Maszynowe uchwyty spawalnicze TIG

Maszynowe uchwyty spawalnicze TIG	23
-----------------------------------	----

Zestaw z częściami szybkozużywającymi się

Zestaw z częściami szybkozużywającymi się	24
---	----

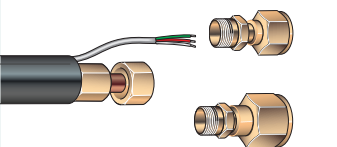
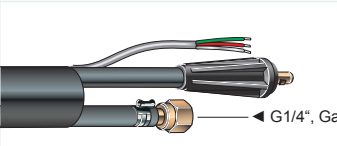
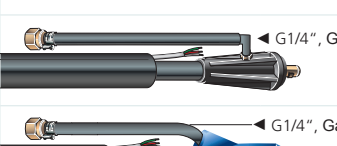
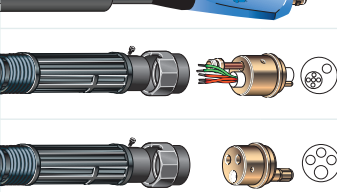

Chłodzone gazem

			TBi SR 9 (FX)	TBi SR 17 (FX)	TBi SR 26 (FX)	TBi SR 24G
	M12x1	Standard Standard, FX	415P09 0 413P09 0	415P17 0 413P17 0	415P26 0 413P26 0	415P23 0 -
	G 1/4"	Standard Standard, FX	415P09 2 413P09 2	415P17 2 413P17 2	415P26 2 413P26 2	415P23 2 -
	G 3/8"	Standard Standard, FX	415P09 3 413P09 3	415P17 3 413P17 3	415P26 3 413P26 3	415P23 3 -
	TSB 10/25 (Ø 9 mm)	Standard Standard, FX	415P09 3B 413P09 3B	415P17 3B 413P17 3B	415P26 3B 413P26 3B	415P23 3B -
	TSB 35/50 (Ø 13 mm)	Standard Standard, FX	415P09 3C 413P09 3C	415P17 3C 413P17 3C	415P26 3C 413P26 3C	415P23 3C -
	TSB 10/25 Mono (Ø 9 mm)	Standard Standard, FX	415P09 B 413P09 B	415P17 B 413P17 B	* *	* -
	TSB 35/50 Mono (Ø 13 mm)	Standard Standard, FX	415P09 C 413P09 C	415P17 C 413P17 C	415P26 C 413P26 C	* -
	Euro-W5G	Standard Standard, FX	415P09 Y 413P09 Y	415P17 Y 413P17 Y	415P26 Y 413P26 Y	415P23 Y -
	Euro-GZ	Standard Standard, FX	415P09 9 413P09 9	415P17 9 413P17 9	415P26 8 413P26 8	415P23 9 -

Przyłącza uchwytów do wszystkich typów spawarek TIG są dostępne.

Więcej informacji wg zamówienia

Proszę wskazać wymagany rodzaj mikrowyłącznika

C



Dwufunkcyjny mikrowyłącznik (rodzaj zależny od modelu uchwytu)

P

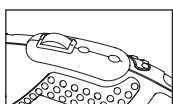

Mikrowyłącznik dwufunkcyjny z potencjometrem 10kOhm

D

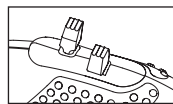

Mikrowyłącznik dwudźwigniowy

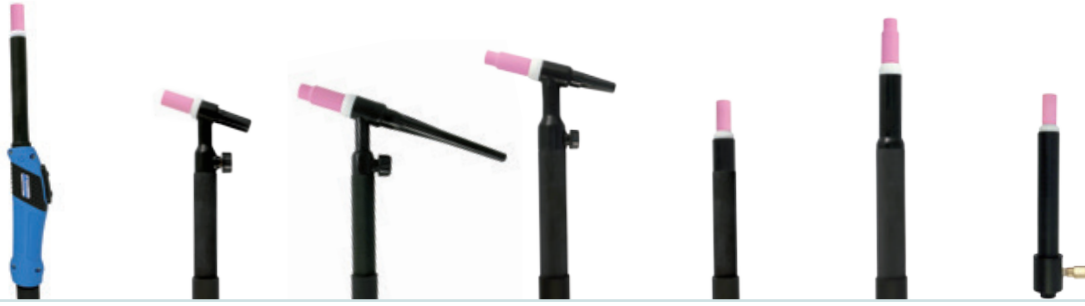

TBi SR 25G FX TBi SR 9 V (FX) TBi SR 17 V (FX) TBi SR 26 V (FX) TBi SR 9 P (Aut) TBi SR 26 P (Aut) TBi Aut 22G

- 413P25 0	405P09V 0 403P09V 0	405P17V 0 403P17V 0	405P26V 0 403P26V 0	491P09700	491P26700	491P23700
- 413P25 2	405P09V 2 403P09V 2	405P17V 2 403P17V 2	405P26V 2 403P26V 2	491P09702	491P26702	491P23702
- 413P25 3	405P09V 3 403P09V 3	405P17V 3 403P17V 3	405P26V 3 403P26V 3	491P09703	491P26703	491P23703
- 413P25 3B	405P09V3B 403P09V3B	405P17V3B 403P17V3B	405P26V3B 403P26V3B	491P0970B	-	491P2373B
- 413P25 3C	405P09V3C 403P09V3C	405P17V3C 403P17V3C	405P26V3C 403P26V3C	491P0970C	491P2673C	491P2373C
- *	* *	* *	* *	* -	* -	491P2371B
- *	* *	* *	* *	* -	* -	491P2371C
- 413P25 Y	* *	* *	* *	* -	* -	* -
- 413P25 9	* *	* *	* *	491P09709	491P26708	* -

Proszę wskazać wymagany typ przewodu osłonowego

- 1** Gumowy przewód osłonowy (standard)
- L** Gumowy przewód osłonowy z przewodem osłonowym skórzanym (0.6 m) z przodu
- T** Tekstylny przewód osłonowy

Proszę wskazać wymaganą długość uchwytu spawalniczego TIG

- 4** 4 m / 12 ft
- 8** 8 m / 25 ft

* Nr. Katalogowy wg zamówienia



Chłodzone cieczą

			TBi SR 18 (FX)	TBi SR 20 (FX)	TBi SR 21 (FX)	TBi SR 24W (FX)
<p>G1/4", Gaz</p> <p>G3/8", Ciecz</p>	M12x1	Standard Standard, FX	415P18 0 413P18 0	415P20 0 413P20 0	415P21 0 413P21 0	415P24 0 413P24 0
	G 1/4"	Standard Standard, FX	415P18 2 413P18 2	415P20 2 413P20 2	415P21 2 413P21 2	415P24 2 413P24 2
	G 3/8"	Standard Standard, FX	415P18 3 413P18 3	415P20 3 413P20 3	415P21 3 413P21 3	415P24 3 413P24 3
<p>Ciecz</p> <p>Ciecz G1/4", Gaz</p>	TSB 35/50 (Ø 13 mm)	Standard Standard, FX	415P18 C 413P18 C	415P20 C 413P20 C	415P21 C 413P21 C	415P24 C 413P24 C
	Euro-W5W	Standard Standard, FX	415P18 Y 413P18 Y	415P20 Y 413P20 Y	415P21 Y 413P21 Y	415P24 Y 413P24 Y
	Euro-WZ-0	Standard Standard, FX	415P18 5 413P18 5	415P20 5 413P20 5	415P21 5 413P21 5	415P24 5 413P24 5

Przyłącza uchwytów do wszystkich typów spawarek TIG są dostępne.
Więcej informacji wg zamówienia

Proszę wskazać wymagany rodzaj mikrowyłącznika

C

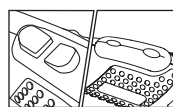

Dwufunkcyjny mikrowyłącznik
(rodzaj zależny od modelu uchwytu)

P

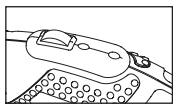

Mikrowyłącznik dwufunkcyjny z
potencjometrem 10kOhm

D

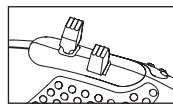

Mikrowyłącznik dwudźwigniowy



TBi SR 25W FX	TBi AW 424	TBi AW 427	TBi SR 400	TBi XCT 400W	TBi SR 12	TBi SR 18 V (FX)	TBi SR 20 V (FX)
- 401P25 0	414P24 0 -	404P27 0 -	415P40 0 -	415PX4 0 -	405P12R 0 -	405P18V 0 403P18V 0	405P20V 0 403P20V 0
- 401P25 2	414P24 2 -	404P27 2 -	415P40 2 -	415PX4 2 -	405P12R12 -	405P18V 2 403P18V 2	405P20V 2 403P20V 2
- 401P25 3	414P24 3 -	404P27 3 -	415P40 3 -	415PX4 3 -	405P12R13 -	405P18V 3 403P18V 3	405P20V 3 403P20V 3
- 401P25 C	414P24 C -	404P27 C -	415P40 C -	415PX4 C -	405P12R1C -	405P18V C 403P18V C	405P20V C 403P20V C
- 401P25 Y	414P24 Y -	404P27 Y -	415P40 Y -	415PX4 Y -	405P12R1Y -	405P18V Y 403P18V Y	405P20V Y 403P20V Y
- 401P25 5	414P24 5 -	404P27 5 -	415P40 5 -	415PX4 5 -	405P12R15 -	405P18V 5 403P18V 5	405P20V 5 403P20V 5

Proszę wskazać wymagany typ przewodu osłonowego

- 1** Gumowy przewód osłonowy (standard)
- L** Gumowy przewód osłonowy z przewodem osłonowym skórzanym (0.6 m) z przodu
- T** Tekstylny przewód osłonowy

Proszę wskazać wymaganą długość uchwytu spawalniczego TIG

- 4** 4 m / 12 ft
- 8** 8 m / 25 ft

* Nr. Katalogowy wg zamówienia



Chłodzone cieczą

			TBi SR 18 P (Aut)	TBi SR 20 P (Aut)	TBi Aut 22W
	M12x1	Standard	491P18700	491P20700	491P22700
	G 1/4"	Standard	491P18702	491P20702	491P22702
	G 3/8"	Standard	491P18703	491P20703	491P22703
	TSB 35/50 (Ø 13 mm)	Standard	491P1870C	491P2070C	491P2270C
	Euro-W5W	Standard	491P1870Y	491P2070Y	491P2270Y
	Euro-WZ-0	Standard	491P18705	491P20705	491P22705

Przyląca uchwytów do wszystkich typów spawarek TIG są dostępne.

Więcej informacji wg zamówienia

Proszę wskazać wymaganą długość uchwytu spawalniczego TIG

4 4 m / 12 ft

8 8 m / 25 ft

Modele z mikrowyłącznikiem łopatkowym



Chłodzone gazem

	TSB 35/50 (Ø 13 mm)	Standard Standard, FX	TBi SR 9 (FX)		TBi SR 17 (FX)		TBi SR 26 (FX)		TBi SR 24G	
			405P917 1 403P917 1	405P917 2 403P917 2	405P917 5 403P917 5	405P917 7 -				
	TSB 35/50 Mono (Ø 13 mm)	Standard Standard, FX	TBi SR 18 (FX)		TBi SR 20 (FX)		TBi SR 21 (FX)		TBi SR 400	
			405P91761 403P91761	405P91762 403P91762	405P91765 403P91765	405P91767 -				

Chłodzone cieczą

	TSB 35/50 (Ø 13 mm)	Standard Standard, FX	TBi SR 18 (FX)		TBi SR 20 (FX)		TBi SR 21 (FX)		TBi SR 400		TBi SR 24W (FX)	
			405P917 3 403P917 3	405P917 4 403P917 4	405P917 9 -	405P917 8 -	405P917 6 403P917 6					

Proszę wskazać wymagany typ przewodu osłonowego

- 5** Gumowy przewód osłonowy (standard)
- L** Gumowy przewód osłonowy z przewodem osłonowym skórzanym (0.6 m) z przodu
- T** Tekstylny przewód osłonowy

Proszę wskazać wymaganą długość uchwytu spawalniczego TIG

- 4** 4 m / 12 ft
- 8** 8 m / 25 ft

Inne modele dostępne na żądanie

TBi SR 25G,
TBi SR 25W,
TBi AW 424,
TBi AW 428

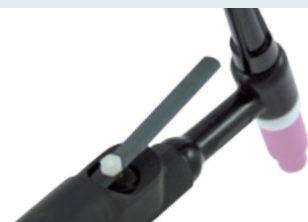

Uwaga

Proszę zwrócić uwagę, że korpusy uchwytów TBi SR18, TBi SR26, TBi SR400 są inne od korpusów dla rękojeści typu Precision.

TBi SR 9 , TBi SR 20 , TBi SR 21



TBi SR 9 (FX)
 Chłodzenie gazem
 60% (10 min.)
 AC: 80 A
 DC: 110 A
 Ø 0.5 - 1.6 mm



TBi SR 20 (FX)
 Chłodzenie cieczą
 100% (10 min.)
 AC: 160 A
 DC: 220 A
 Ø 0.5 - 3.2 mm



TBi SR 21 (FX)
 Chłodzenie cieczą
 100% (10 min.)
 AC: 240 A
 DC: 340 A
 Ø 0.5 - 3.2 mm

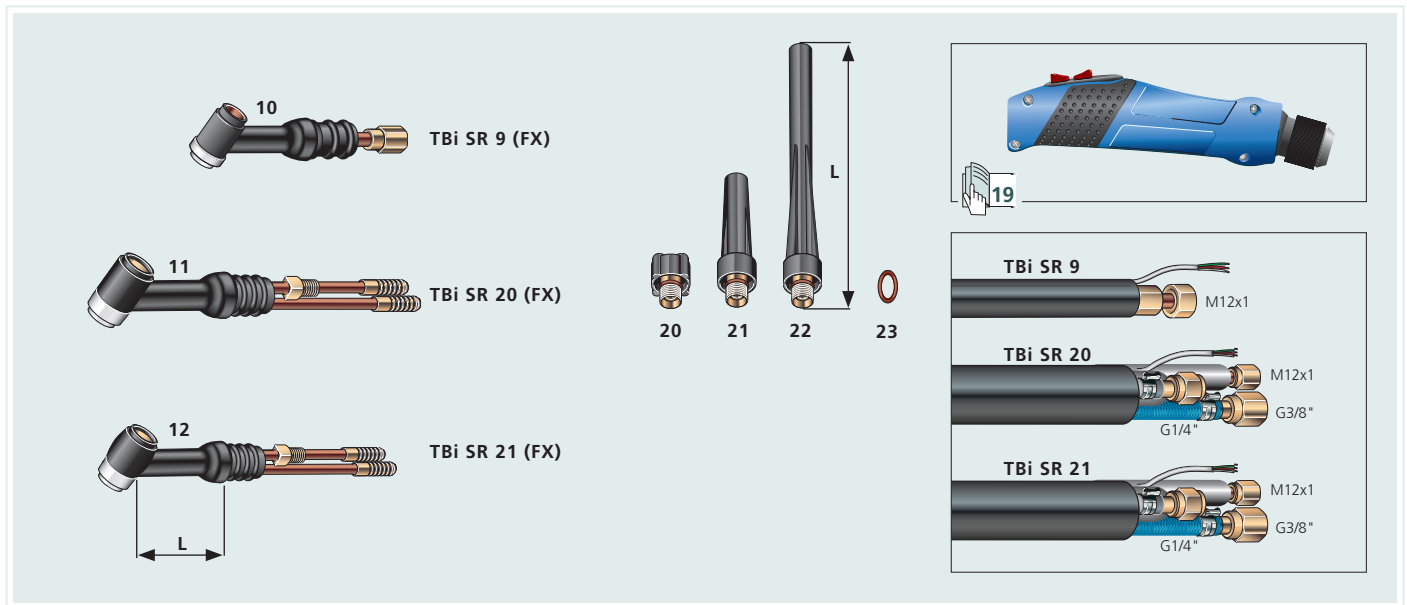

Części zamienne

10	Korpus uchwyty	SR 9		L = 35 mm	405P090800
10	Korpus uchwyty	SR 9 FX (Standard)	giętki	L = 35 mm	403P090800
10	Korpus uchwyty	SR 9 FX-L	giętki	L = 115 mm	403P090805
11	Korpus uchwyty	SR 20		L = 35 mm	405P200800
11	Korpus uchwyty	SR 20 FX (Standard)	giętki	L = 35 mm	403P200700
11	Korpus uchwyty	SR 20 FX-L	giętki	L = 70 mm	403P200850
11	Korpus uchwyty	SR 20 FX-LL	giętki	L = 90 mm	403P200750
11	Korpus uchwyty	SR 20 FX-XL	giętki	L = 115 mm	403P200800
12	Korpus uchwyty	SR 21		L = 35 mm	405P210800
12	Korpus uchwyty	SR 21 FX (Standard)	giętki	L = 65 mm	403P210700
12	Korpus uchwyty	SR 21 FX-L	giętki	L = 115 mm	403P210701
20	Korek tylni	krótki		L = 18 mm	41V33 401P200100
21	Korek tylni	średni		L = 48 mm	41V35 401P200200
22	Korek tylni	długi		L = 145 mm	41V24 401P200300
23	O-ring (uszczelka)				98W77 365P200046

► Części szybko zużywające się

A	Izolator	Standard	598882	402P200900
B	Izolator wielki przepływu laminarnego	Jumbo przepływ laminarny	54N63-20	401P200905

► = Standard

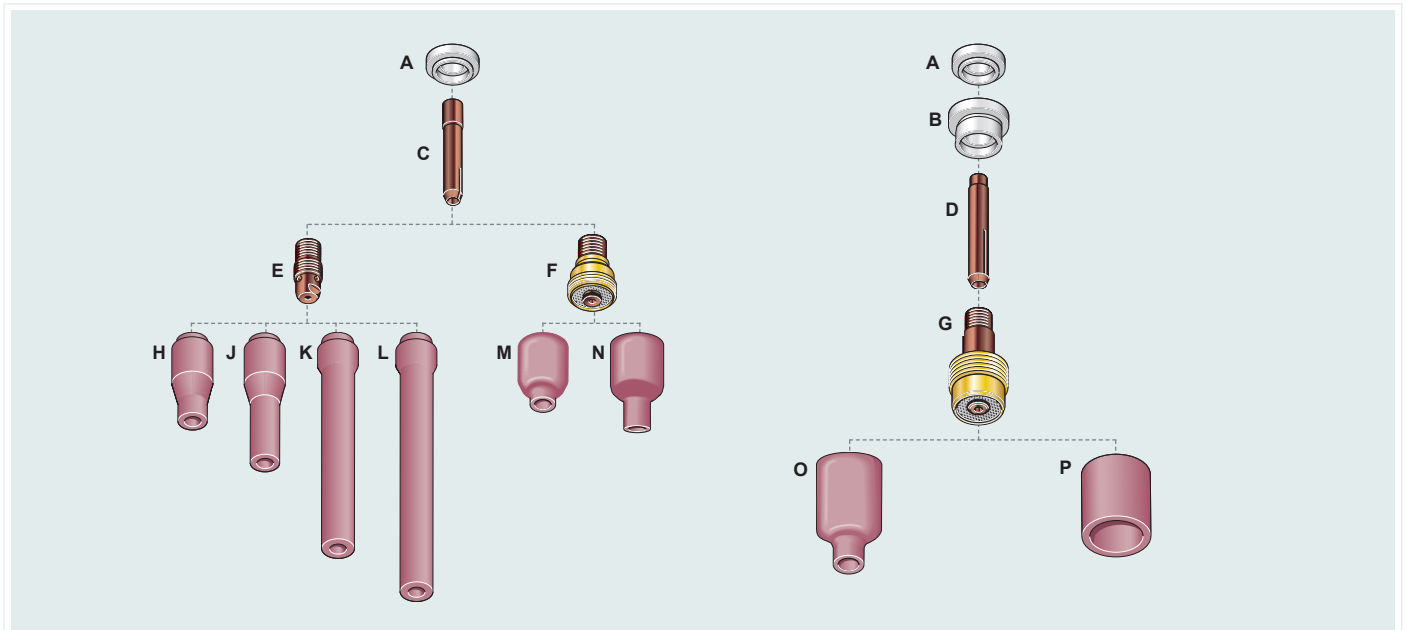

		Ø 0.5 mm Ø 0.020"	Ø 1.0 mm Ø 0.040"	Ø 1.6 mm Ø 1/16"	Ø 2.0 mm	Ø 2.4 mm Ø 3/32"	Ø 3.0 mm	Ø 3.2 mm Ø 1/8"
Tulejki zaciskowe								
▶ C	Standard, Długość 25.4 mm	13N20 401P200599	13N21 401P200600	13N22 401P200601	- 401P200604	13N23 401P200602	- 401P200605	13N24 401P200603
D	Jumbo, Długość 40.1 mm	-	13N21L 401P13N21L	13N22L 401P13N22L	-	13N23L 401P13N23L	-	13N24L 401P13N24L
Oprawki tulejek zaciskowych								
▶ E	Długość 20.6 mm	13N25 401P200999	13N26 401P201000	13N27 401P201001	- 401P201005	13N28 401P201002	- 401P201006	13N29 401P201003
Przeptyw laminarny								
F	Standard, Długość 21.5 mm	-	45V42 401P201300	45V43 401P201301	- 401P201304	45V44 401P201302	- 401P201305	45V45 401P201303
G	Jumbo, Długość 40.5 mm	-	45V0204S 401P201350	45V116S 401P201351	-	45V64S 401P201352	-	995795S 401P201353

		No. 3 Ø 5.0 mm Ø 3/16"	No. 4 Ø 6.5 mm Ø 1/4"	No. 5 Ø 8.0 mm Ø 5/16"	No. 6 Ø 9.5 mm Ø 3/8"	No. 7 Ø 11 mm Ø 7/16"	No. 8 Ø 12.5 mm Ø 1/2"	No. 10 Ø 16 mm Ø 5/8"
Dysze ceramiczne								
▶ H	Standard, Długość 30 mm	-	13N08 401P201106	13N09 401P201107	13N10 401P201108	13N11 401P201109	13N12 401P201110	13N13 401P201111
J	Standard, L, Długość 48 mm	796F70 401P201115	796F71 401P201116	796F72 401P201117	796F73 401P201118	-	-	-
K	Standard, XL, Długość 63 mm	-	796F75 401P201126	796F76 401P201127	796F77 401P201128	-	-	-
L	Standard, XXL, Długość 89 mm	-	796F79 401P201136	-	-	-	-	-

		No. 4 Ø 6.5 mm Ø 1/4"	No. 5 Ø 8.0 mm Ø 5/16"	No. 6 Ø 9.5 mm Ø 3/8"	No. 7 Ø 11 mm Ø 7/16"	No. 8 Ø 12.5 mm Ø 1/2"	No. 10 Ø 16 mm Ø 5/8"	No. 12 Ø 19 mm Ø 3/4"	Ø 24 mm
Dysze ceramiczne									
M	Przeptyw laminarny, Długość 25.5 mm	53N58 401P201400	53N59 401P201401	53N60 401P201402	53N61 401P201403	53N61S 401P201404	-	-	-
N	Przeptyw laminarny, L, Długość 35 mm	53N58L 401P201408	53N59L 401P201405	53N60L 401P201406	53N61L 401P201407	-	-	-	-
O	Jumbo Przeptyw laminarny, Długość 48 mm	-	-	57N75 401P201451	-	57N74 401P201452	53N88 401P222250	53N87 401P222251	53N89-L 401P222253
P	Jumbo Przeptyw laminarny, Długość 34 mm	-	-	-	-	-	-	-	53N89 401P222252

▶ = Standard

TBi SR 17 , TBi SR 18 , TBi SR 26



TBi SR 17 (FX)
 Chłodzenie gazem
 60% (10 min.)
 AC: 100 A
 DC: 140 A
 Ø 0.5 - 2.4 mm



TBi SR 18 (FX)
 Chłodzenie cieczą
 100% (10 min.)
 AC: 225 A
 DC: 320 A
 Ø 0.5 - 4.0 mm



TBi SR 26 (FX)
 Chłodzenie gazem
 60% (10 min.)
 AC: 170 A
 DC: 240 A
 Ø 0.5 - 4.0 mm

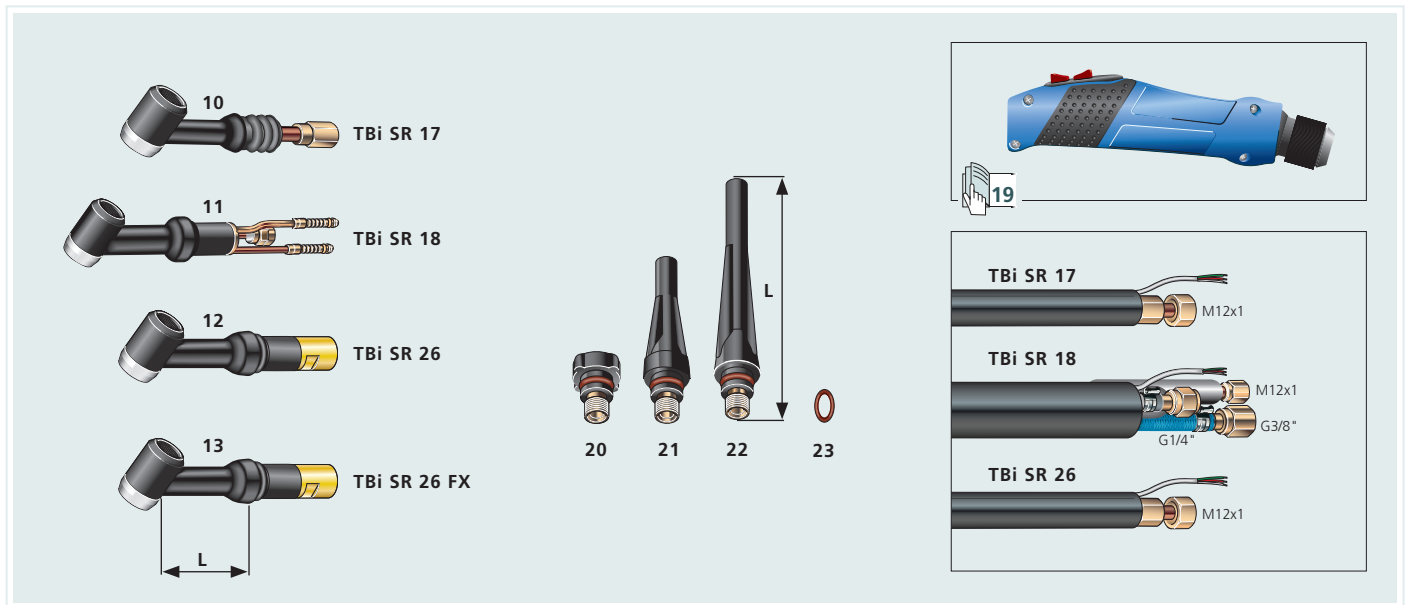

Części zamienne

10	Korpus uchwytu	SR 17		L = 50 mm	405P170700
10	Korpus uchwytu	SR 17 FX	giętki	L = 50 mm	403P170700
11	Korpus uchwytu	SR 18		L = 50 mm	405P180702
11	Korpus uchwytu	SR 18 FX	giętki	L = 50 mm	403P180702
12	Korpus uchwytu	SR 26		L = 50 mm	405P260702
13	Korpus uchwytu	SR 26 FX	giętki	L = 50 mm	403P260702
20	Korek tylni	krótki		L = 24 mm	57Y04 402P170100
21	Korek tylni	średni		L = 58 mm	57Y05 402P170150
22	Korek tylni	długi		L = 140 mm	57Y02 402P170200
23	O-ring (uszczelka)				98W18 365P200096

Części szybkozużywające się



B	Izolator	mały, przepływ laminarny		402P956100
C	Izolator	standard	18CG	403P171000
D	Izolator	Przepływ laminarny	54N01	401P181100
E	Izolator wielki przepływu laminarnego	Jumbo Przepływ laminarny	54N63	401P171105

► = Standard

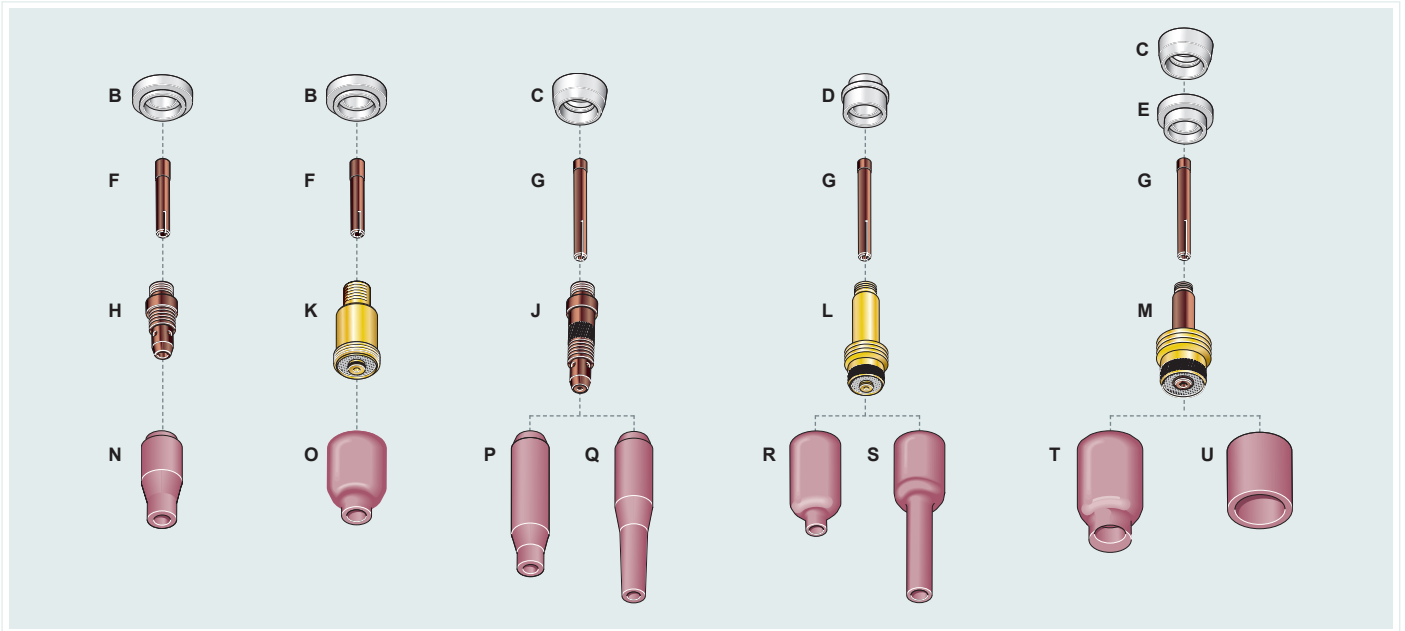

	Ø 0.5 mm Ø 0.020"	Ø 1.0 mm Ø 0.040"	Ø 1.6 mm Ø 1/16"	Ø 2.0 mm	Ø 2.4 mm Ø 3/32"	Ø 3.0 mm	Ø 3.2 mm Ø 1/8"	Ø 4.0 mm Ø 5/32"
--	----------------------	----------------------	---------------------	----------	---------------------	----------	--------------------	---------------------

Tulejki zaciskowe

F	krótka Długość = 29.3 mm	-	10N22S 402P10N22S	10N23S 402P10N23S	-	10N24S 402P10N24S	-	10N25S 402P10N25S	-
G	Standard Długość = 50 mm	10N21 402P170499	10N22 402P170500	10N23 402P170502	402P170506	402P170503	402P170507	402P170504	54N20 402P170505

Oprawki tulejek zaciskowych

H	krótka Długość = 24.5 mm	-	17CB21 402P17CB21	17CB22 402P17CB22	-	17CB23 402P17CB23	-	17CB24 402P17CB24	-
J	Standard Długość = 47 mm	10N29 401P180997	10N30 401P180998	10N31 401P180999	401P181003	10N32 401P181000	401P181004	10N28 401P181001	406488 401P181002

Przepływ laminarny

K	krótka Długość = 21.5 mm	-	-	-	-	-	-	-	-
L	Standard Długość = 50 mm	-	45V24 401P181299	45V25 401P181300	401P181304	45V26 401P181301	401P181305	45V27 401P181302	45V28 401P181303
M	Jumbo Długość = 50 mm	-	45V0204 401P181350	45V116 401P181351	-	45V64 401P181352	-	995795 401P181353	45V63 401P181354

	No. 4 Ø 6.5 mm Ø 1/4"	No. 5 Ø 8.0 mm Ø 5/16"	No. 6 Ø 9.5 mm Ø 3/8"	No. 7 Ø 11 mm Ø 7/16"	No. 8 Ø 12.5 mm Ø 1/2"	No. 10 Ø 16 mm Ø 5/8"	No. 11 Ø 17.5 mm Ø 11/16"	No. 12 Ø 19 mm Ø 3/4"	Ø 24.0 mm
--	-----------------------------	------------------------------	-----------------------------	-----------------------------	------------------------------	-----------------------------	---------------------------------	-----------------------------	-----------

Dysze ceramiczne

N	krótka Długość = 30 mm	13N08 401P201106	13N09 401P201107	13N10 401P201108	13N11 401P201109	13N12 401P201110	13N13 401P201111	-	-	-
O	Przepływ laminarny krótki Długość = 25.5 mm	53N58 401P201400	53N59 401P201401	53N60 401P201402	53N61 401P201403	53N61S 401P201404	-	-	-	-
P	Standard Długość = 47 mm	10N50 401P170907	10N49 401P170908	10N48 401P170909	10N47 401P170910	10N46 401P170911	10N45 401P170912	-	10N44 401P170913*	-
Q	Standard, L Długość = 76 mm	10N50L 401P170923	10N49L 401P170914	10N48L 401P170915	10N47L 401P170916	-	-	-	-	-
R	Przepływ laminarny Długość = 42 mm	54N18 401P222200	54N17 401P222201	54N16 401P222202	54N15 401P222203	54N14 401P222204	-	54N19 401P222206	-	-
S	Przepływ laminarny, L Długość = 76 mm	54N18 L 401P222211	54N17 L 401P222207	54N16 L 401P222208	54N15 L 401P222209	54N14 L 401P222210	-	-	-	-
T	Jumbo Przepływ laminarny Długość = 48 mm	-	-	57N75 401P201451	-	57N74 401P201452	53N88 401P222250	-	53N87 401P222251	53N89-L 401P222253
U	Jumbo Przepływ laminarny Długość = 34 mm	-	-	-	-	-	-	-	-	53N89 401P222252

* Długość = 50 mm

► = Standard

TBi SR 24G , TBi SR 24W



TBi SR 24G / TBi SR 24W

TBi SR 24G

Chłodzenie gazem
60% (10 min.)
AC: 80 A
DC: 110 A
Ø 0.5 - 1.6 mm

TBi SR 24W (FX)

Chłodzenie cieczą
100% (10 min.)
AC: 100 A
DC: 140 A
Ø 0.5 - 2.4 mm

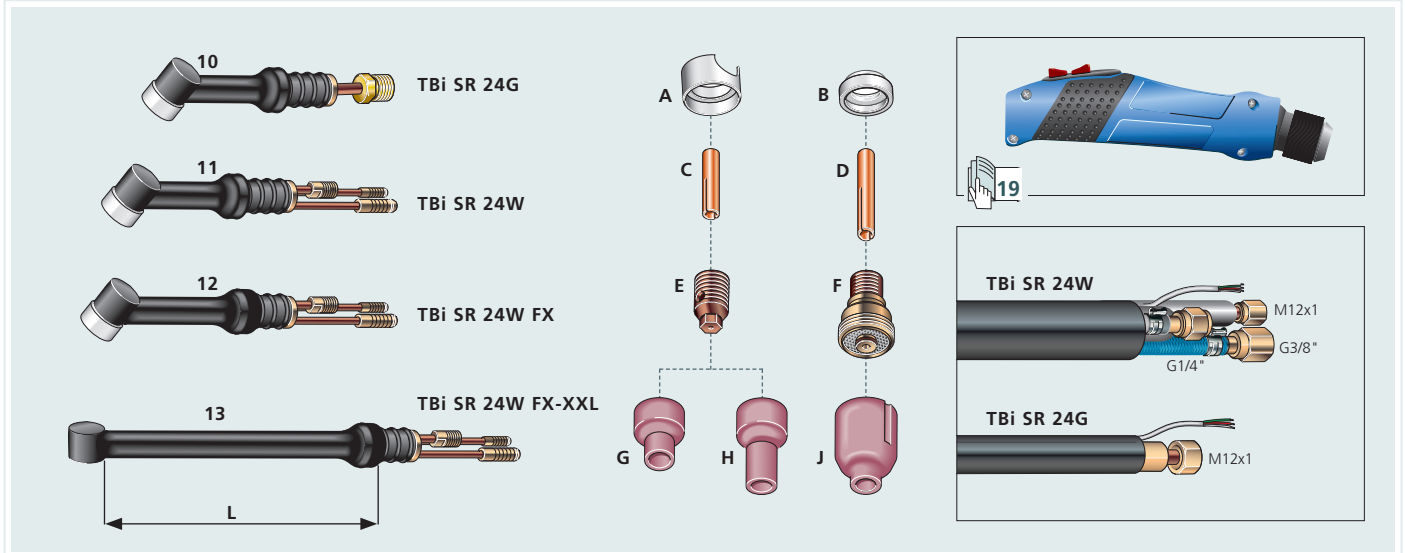

Części zamienne

10	Korpus uchwytu	SR 24G		L = 50 mm	405P240800
11	Korpus uchwytu	SR 24W		L = 50 mm	405P240850
12	Korpus uchwytu	SR 24W FX (Standard)	giętki	L = 65 mm	403P240700
12	Korpus uchwytu	SR 24W FX-L	giętki	L = 90 mm	403P240750
12	Korpus uchwytu	SR 24W FX-XL	giętki	L = 115 mm	403P240701
13	Korpus uchwytu	SR 24W FX-XXL	giętki	L = 290 mm	403P240770
▶ A	Izolator			53N22	401P240700*
B	Izolator	Przepływ laminarny		53N66	401P240701

	Ø 0.5 mm Ø 0.020"	Ø 1.0 mm Ø 0.040"	Ø 1.6 mm Ø 1/16"	Ø 2.4 mm Ø 3/32"
--	----------------------	----------------------	---------------------	---------------------

Tulejki zaciskowe

▶ C	Długość=14.0 mm	53N15 401P240500	53N16 401P240501	53N14 401P240502	24C332 401P240505
D	Gas lens, Długość=23.0 mm	-	53N63 401P240802	53N64 401P240803	24GLC332 401P240805

Oprawki tulejek zaciskowych

▶ E	Długość=12.0 mm	53N17 401P241000	53N18 401P241001	53N19 401P241002	24CB332 401P241003
-----	-----------------	---------------------	---------------------	---------------------	-----------------------

Przepływ laminarny

F	Długość=21.5 mm	-	45V42 401P201300	45V43 401P201301	45V44 401P201302
---	-----------------	---	---------------------	---------------------	---------------------

	No. 4 Ø 6.5 mm Ø 1/4"	No. 5 Ø 8.0 mm Ø 5/16"	No. 6 Ø 9.5 mm Ø 3/8"	No. 7 Ø 11 mm Ø 7/16"	No. 8 Ø 12.5 mm Ø 1/2"
--	-----------------------------	------------------------------	-----------------------------	-----------------------------	------------------------------

Dysze ceramiczne

▶ G	Standard, Długość=16.5 mm	53N24 401P240900	53N25 401P240901	53N27 401P240902	-	-
H	Standard , długa Długość=29.0 mm	53N24L 401P240903	-	53N26L 401P240904	-	-
J	Przepływ laminarny	53N58 401P201400	53N59 401P201401	53N60 401P201402	53N61 401P201403	53N61S 401P200404

▶ = Standard

* Nie kompatybilne z korpus uchwytu SR 24W FX-XXL



TBi SR 25G FX
 Chłodzenie gazem
 60% (10 min.)
 AC: 80 A
 DC: 110 A
 Ø 0.5 - 2.4 mm

TBi SR 25W FX
 Chłodzenie cieczą
 100% (10 min.)
 AC: 100 A
 DC: 140 A
 Ø 0.5 - 3.2 mm

TBi SR 25G FX / TBi SR 25W FX

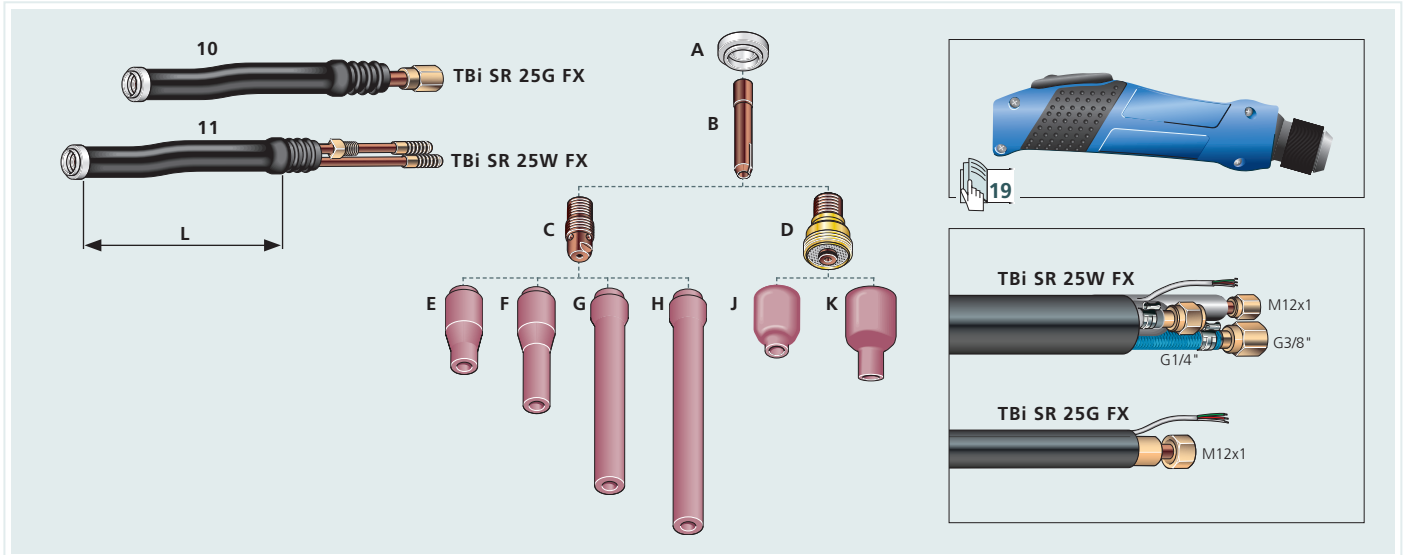

Części zamienne

10	Korpus uchwyty	SR 25G FX	giętki	L = 120 mm	401P250200
11	Korpus uchwyty	SR 25W FX (Standard)	giętki	L = 120 mm	401P251200
11	Korpus uchwyty	SR 25W FX-L	giętki	L = 300 mm	401P251201
A	Izolator			598882-D	401P200950

	Ø 0.5 mm Ø 0.020"	Ø 1.0 mm Ø 0.040"	Ø 1.6 mm Ø 1/16"	Ø 2.0 mm	Ø 2.4 mm Ø 3/32"	Ø 3.0 mm	Ø 3.2 mm Ø 1/8"
--	----------------------	----------------------	---------------------	----------	---------------------	----------	--------------------

Tulejki zaciskowe

▶ B	Standard, Długość=25.4 mm	13N20 401P200599	13N21 401P200600	13N22 401P200601	- 401P200604	13N23 401P200602	- 401P200605	13N24 401P200603
-----	---------------------------	---------------------	---------------------	---------------------	-----------------	---------------------	-----------------	---------------------

Oprawki tulejek zaciskowych

▶ C	Długość=20.6 mm	13N25 401P200999	13N26 401P201000	13N27 401P201001	- 401P201005	13N28 401P201002	- 401P201006	13N29 401P201003
-----	-----------------	---------------------	---------------------	---------------------	-----------------	---------------------	-----------------	---------------------

Przeptyw laminarny

D	Długość=21.5 mm	-	45V42 401P201300	45V43 401P201301	- 401P201304	45V44 401P201302	- 401P201305	45V45 401P201303
---	-----------------	---	---------------------	---------------------	-----------------	---------------------	-----------------	---------------------

	No. 3 Ø 5.0 mm Ø 3/16"	No. 4 Ø 6.5 mm Ø 1/4"	No. 5 Ø 8.0 mm Ø 5/16"	No. 6 Ø 9.5 mm Ø 3/8"	No. 7 Ø 11 mm Ø 7/16"	No. 8 Ø 12.5 mm Ø 1/2"	No. 10 Ø 16 mm Ø 5/8"
--	------------------------------	-----------------------------	------------------------------	-----------------------------	-----------------------------	------------------------------	-----------------------------

Dysze ceramiczne

▶ E	Standard, Długość=30 mm	-	13N08 401P201106	13N09 401P201107	13N10 401P201108	13N11 401P201109	13N12 401P201110	13N13 401P201111
F	Standard, L, Długość=48 mm	796F70 401P201115	796F71 401P201116	796F72 401P201117	796F73 401P201118	-	-	-
G	Standard, XL, Długość=63 mm	-	796F75 401P201126	796F76 401P201127	796F77 401P201128	-	-	-
H	Standard, XXL, Długość=89 mm	-	796F79 401P201136	-	-	-	-	-
J	Przeptyw laminarny, Długość=25.5 mm	-	53N58 401P201400	53N59 401P201401	53N60 401P201402	53N61 401P201403	53N61S 401P201404	-
K	Przeptyw laminarny, L, Długość=35 mm	-	53N58L 401P201408	53N59L 401P201405	53N60L 401P201406	53N61L 401P201407	-	-

▶ = Standard

TBi AW 424 , TBi AW 427



TBi AW 424
 Chłodzenie cieczą
 100% (10 min.)
 AC: 280 A
 DC: 400 A
 Ø 1.0 - 4.0 mm



TBi AW 427
 Chłodzenie cieczą
 100% (10 min.)
 AC: 350 A
 DC: 500 A
 Ø 2.4 - 8.0 mm

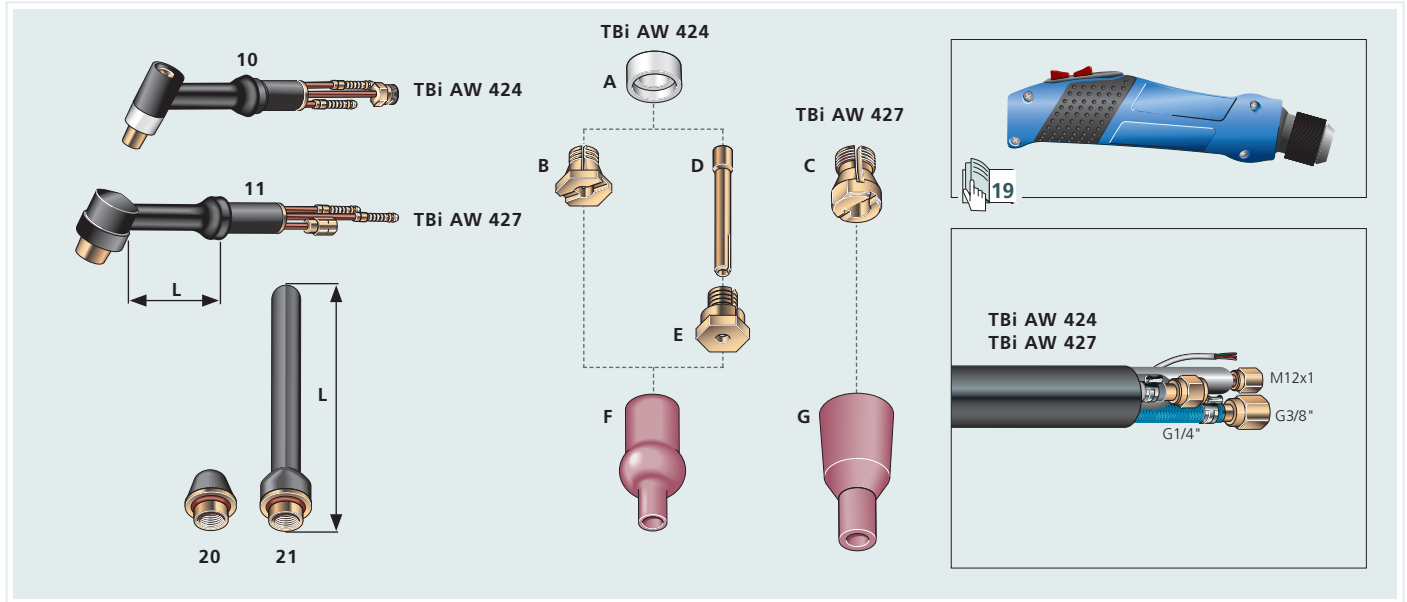

Części zamienne

10	Korpus uchwytu	AW 424	L = 55 mm	404P240702
11	Korpus uchwytu	AW 427	L = 55 mm	404P270702
20	Korek tylni	krótki	L = 16 mm	411-30 404P240100
21	Korek tylni	długi	L = 101 mm	411-70 404P240200
A	Izolator	AW 424	200 NG	404P280300

	Ø 1.0 mm Ø 0.040"	Ø 1.6 mm Ø 1/16"	Ø 2.4 mm Ø 3/32"	Ø 3.2 mm Ø 1/8"	Ø 4.0 mm Ø 5/32"	Ø 4.8 mm Ø 3/16"	Ø 6.4 mm Ø 1/4"	Ø 8.0 mm Ø 5/16"
--	----------------------	---------------------	---------------------	--------------------	---------------------	---------------------	--------------------	---------------------

Zacisk elektrody

B	AW 424, Długość=10.5 mm	-	221.00 404P240501	222.00 404P240502	223.00 404P240503	224.00 404P240504	-	-	-
C	AW 427, Długość=17 mm	-	-	223-07 404P270499	224-07 404P270500	225-07 404P270501	226-07 404P270502	227-07 404P270503	228-07 404P270504

Tulejki zaciskowe

D	AW 424, Długość=59 mm	964.01 404P240602	965.01 404P240603	966.01 404P240604	967.01 404P240605	968.01 404P240606	-	-	-
---	--------------------------	----------------------	----------------------	----------------------	----------------------	----------------------	---	---	---

Oprawki tulejek zaciskowych

E	AW 424, Długość=10.5 mm	961.41 404P240902	961.51 404P240903	961.61 404P240904	961.71 404P240905	961.81 404P240906	-	-	-
---	----------------------------	----------------------	----------------------	----------------------	----------------------	----------------------	---	---	---

	No. 4 Ø 6.5 mm Ø 1/4"	No. 5 Ø 8.0 mm Ø 5/16"	No. 6 Ø 9.5 mm Ø 3/8"	No. 7 Ø 11 mm Ø 7/16"	No. 8 Ø 12.5 mm Ø 1/2"	No. 9 Ø 14 mm Ø 9/16"	No. 10 Ø 16 mm Ø 5/8"	Ø 18 mm
--	-----------------------------	------------------------------	-----------------------------	-----------------------------	------------------------------	-----------------------------	-----------------------------	---------

Dysze ceramiczne

F	Standard, Długość=44.0 mm	130-00 404P241100	131-00 404P241101	132-00 404P241102	133-00 404P241103	134-00 404P241104	135-00 404P241105	136-00 404P241106	- 404P241108
G	Standard, Długość=54.0 mm	-	141-00 404P271100	142-00 404P271101	143-00 404P271102	144-00 404P271103	145-00 404P271104	-	-



TBi SR 400
 Chłodzenie cieczą
 100% (10 min.)
 AC: 315 A
 DC: 450 A
 Ø 1.0 - 4.8 mm

TBi SR 400

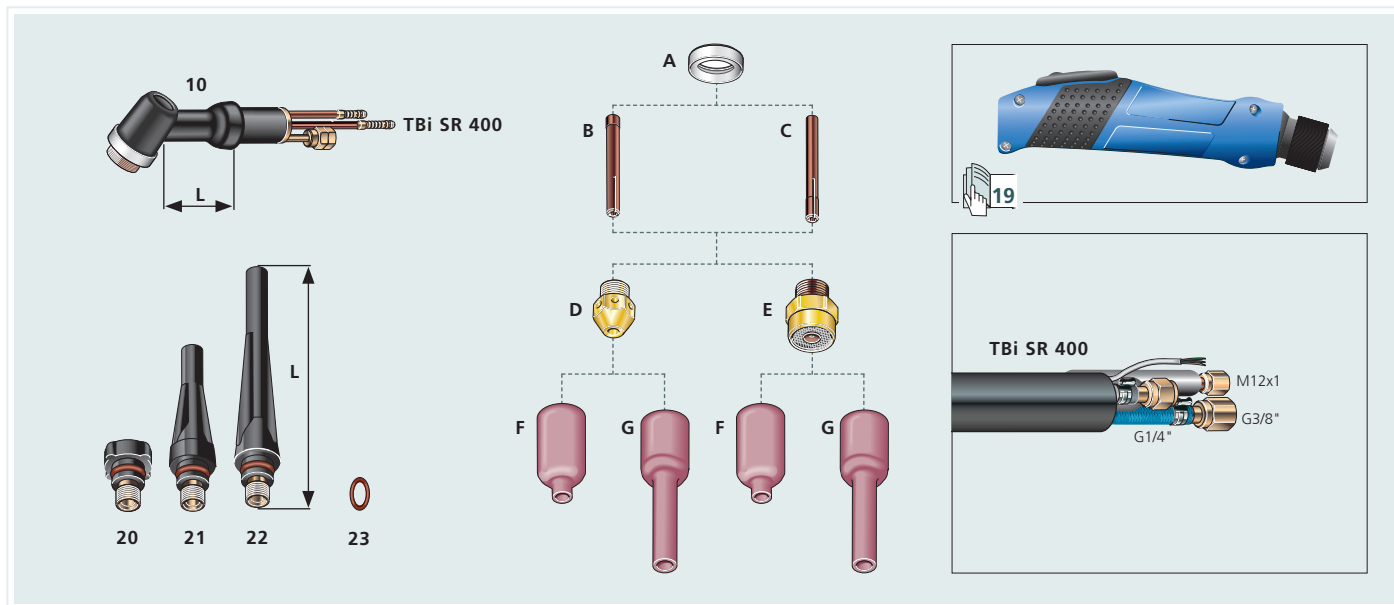

Części zamienne

10	Korpus uchwyty	SR 400	L = 50 mm	405P400802
20	Korek tylni	krótki	L = 24 mm	57Y04 402P170100
21	Korek tylni	średni	L = 58 mm	57Y05 402P170150
22	Korek tylni	długi	L = 140 mm	57Y02 402P170200
23	O-ring (uszczelka)			98W18 365P200096
A	Izolator			18NG 405P400001

	Ø 1.0 mm Ø 0.040"	Ø 1.6 mm Ø 1/16"	Ø 2.4 mm Ø 3/32"	Ø 3.2 mm Ø 1/8"	Ø 4.0 mm Ø 5/32"	Ø 4.8 mm Ø 3/16"
--	----------------------	---------------------	---------------------	--------------------	---------------------	---------------------

Tulejki zaciskowe

▶ B	Standard, Długość=50 mm	10N22 402P170500	10N23 402P170502	10N24 402P170503	10N25 402P170504	54N20 402P170505	-
C	Wysokowydajna, Długość=50 mm	-	-	-	10N25HD 405P400504	54N20HD 405P400505	18C36 405P400506

Oprawki tulejek zaciskowych

▶ D	Długość=19.5 mm	Ø 1.0-3.2 mm 405P401000		Ø 3.2-4.8 mm 405P401001		
-----	-----------------	----------------------------	--	----------------------------	--	--

Przepływ laminarny

E	Długość=21.3 mm	18GL04 405P401301	18GL16 405P401302	18GL32 405P401303	18GL18 405P401304	18GL53 405P401305	18GL36 405P401306
---	-----------------	----------------------	----------------------	----------------------	----------------------	----------------------	----------------------

	No. 4 Ø 6.5 mm Ø 1/4"	No. 5 Ø 8.0 mm Ø 5/16"	No. 6 Ø 9.5 mm Ø 3/8"	No. 7 Ø 11 mm Ø 7/16"	No. 8 Ø 12.5 mm Ø 1/2"	No. 11 Ø 17.5 mm Ø 11/16"
--	-----------------------------	------------------------------	-----------------------------	-----------------------------	------------------------------	---------------------------------

Dysze ceramiczne

▶ F	Standard, Długość=42.0 mm	54N18 401P222200	54N17 401P222201	54N16 401P222202	54N15 401P222203	54N14 401P222204	54N19 401P222206
G	Standard, L, Długość=76.0 mm	54N18 L 401P222211	54N17 L 401P222207	54N16 L 401P222208	54N15 L 401P222209	54N14 L 401P222210	-

▶ = Standard

TBi XCT 400W



TBi XCT 400W
 Chłodzenie cieczą
 100% (10 min.)
 AC: 315 A
 DC: 450 A
 Ø 2.4 - 4.0 mm

TBi XCT 400W

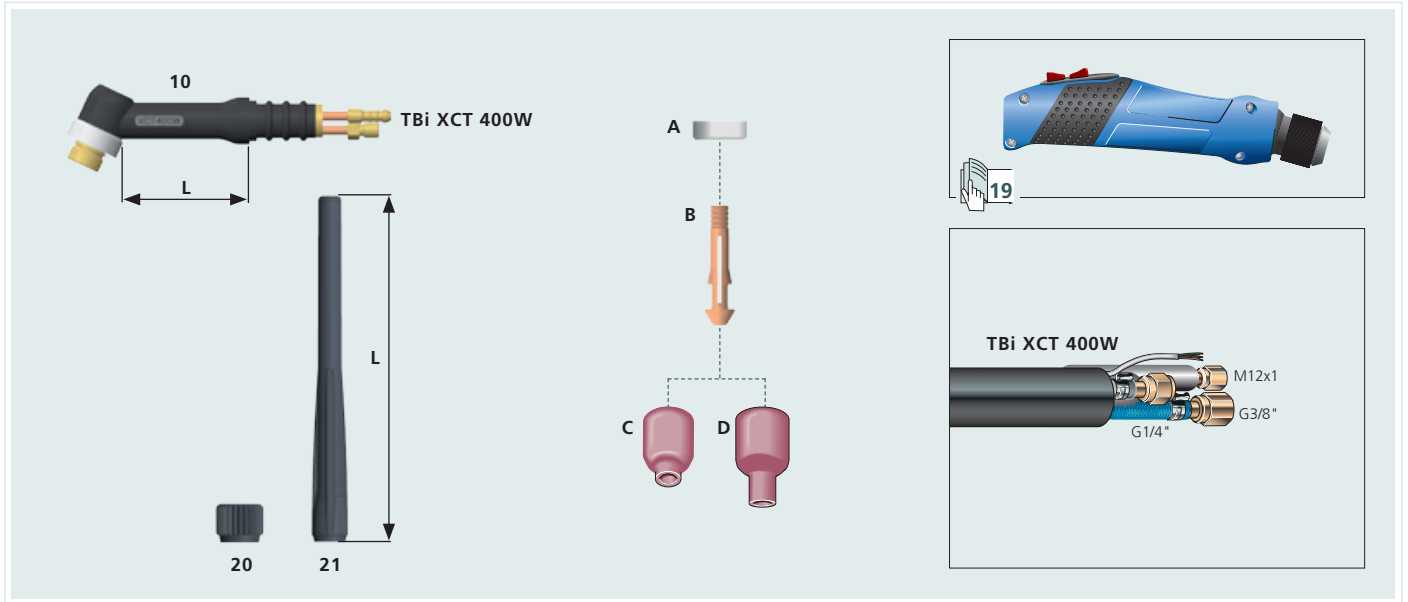

Części zamienne

10	Korpus uchwytu	XCT 400W	L = 52 mm	405PX40700
20	Korek tylni	krótki	L = 13 mm	402PX40600
21	Korek tylni	długi	L = 145 mm	402PX40700
A	Izolator			401PX40700

	Ø 2.4 mm Ø 3/32"	Ø 3.2 mm Ø 1/8"	Ø 4.0 mm Ø 5/32"
--	---------------------	--------------------	---------------------

Tulejka zaciskowa

▶ B	L=44.0 mm	-	401PX40502	-	401PX40503	-	401PX40504
-----	-----------	---	------------	---	------------	---	------------

	No. 4 Ø 6.5 mm Ø 1/4"	No. 5 Ø 8.0 mm Ø 5/16"	No. 6 Ø 9.5 mm Ø 3/8"	No. 7 Ø 11 mm Ø 7/16"	No. 8 Ø 12.5 mm Ø 1/2"
--	-----------------------------	------------------------------	-----------------------------	-----------------------------	------------------------------

Dysze ceramiczne

C	L=25.5 mm	53N58 401P201400	53N59 401P201401	53N60 401P201402	53N61 401P201403	53N61S 401P201404
▶ D	L, L=35.0 mm	53N58L 401P201408	53N59L 401P201405	53N60L 401P201406	53N61L 401P201407	-

▶ = Standard



Rękojeści i moduły

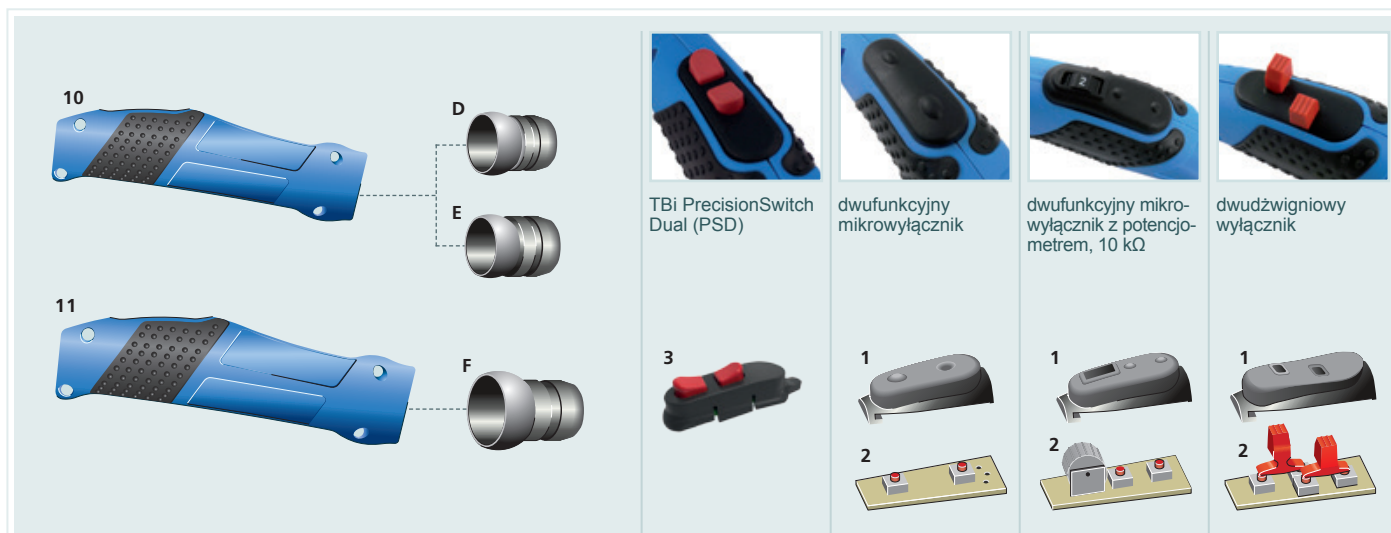

moduły

1	Oslona gumowa	-	401P102022	401P102023	401P102038
2	Płytki sterownicze	-	384P101034	384P101035	384P101050
3	Moduł PSD kompletny	401P101090	-	-	-

Rękojeść z modulem PSD

10	Rękojeść mała, tylko dla uchwytów z modulem PSD SR 9, SR 17, SR 20, SR 21, SR 24, XCT 400W	401P101012	-	-	-
11	Rękojeść duża, tylko dla uchwytów z modulem PSD SR 18, SR 26, AW 424	401P101512	-	-	-

Rękojeści łącznie z modułami

10	Rękojeść mała SR 9, SR 17, SR 20, SR 21, SR 24, SR 25	-	401P101010	401P101020	401P101030
11	Rękojeść duża SR 18, SR 26, SR 400, AW 424, AW 427	-	401P101510	401P101520	401P101530

Części zamienne

D	Przegub kulisty	SR 9, 17, 24 G, 25 G	401P102026
E	Przegub kulisty	SR 20, 21, 24 W, 25 W	401P102029
F	Przegub kulisty	SR 18, 26, 400, AW 424, 427	401P102032

Korpusy uchwytów TIG wraz z osprzętem 10-18

TBi SR 12



TBi SR 12

Chłodzenie cieczą
100% (10 min.)
AC: 350 A
DC: 500 A
Ø 2.4 - 6.4 mm

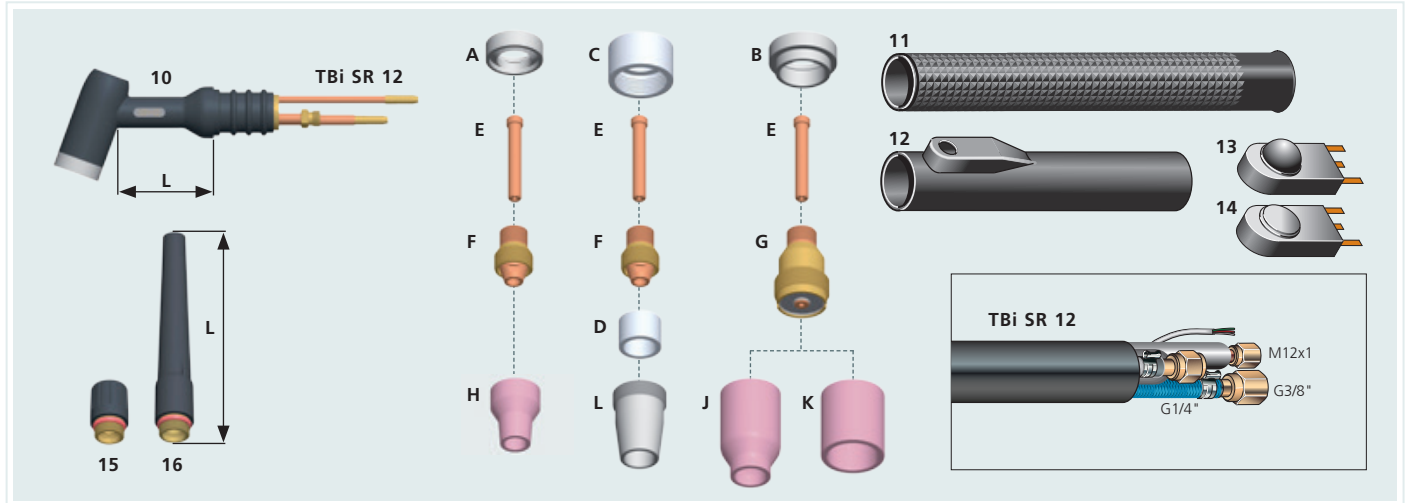

Części zamienne

10	Korpus uchwytu	SR 12	L = 60 mm	405P120800
11	Rekojeść tubowa			85WP13 405P120900
12	Obudowa gumowa mikrowyłącznika			401P120600
13	Mikrowyłącznik	okrągły		385P033009
14	Mikrowyłącznik	plaski		385P233009
15	Korek tylni	krótki	L = 31 mm	56Y45 405P120100
16	Korek tylni	długi	L = 115 mm	56Y44 405P120200
A	Izolator	Standard		12NG 405P120300
B	Izolator	Przepływ laminarny		12GLG 405P120301
C	Izolator	Dysza metalowa		12MNG 405P120302
D	Tulejka izolacyjna			85Z99 405P120303

	Ø 2.4 mm Ø 3/32"	Ø 3.2 mm Ø 1/8"	Ø 4.0 mm Ø 5/32"	Ø 4.8 mm Ø 3/16"	Ø 6.4 mm Ø 1/4"
--	---------------------	--------------------	---------------------	---------------------	--------------------

Tulejki zaciskowe

E	Długość=60,2 mm	85Z15 405P120502	85Z16 405P120503	85Z17 405P120504	85Z18 405P120505	85Z19 405P120506
---	-----------------	---------------------	---------------------	---------------------	---------------------	---------------------

Oprawki tulejek zaciskowych

F	Ø 2.4-6.4 mm 11WP65, 405P121000				
---	------------------------------------	--	--	--	--

Przepływ laminarny

G	11GL32 405P121302	11GL18 405P121303	11GL53 405P121304	11GL36 405P121305	- 405P121306
---	----------------------	----------------------	----------------------	----------------------	-----------------

	No. 4 Ø 6.5 mm Ø 1/4"	No. 5 Ø 8.0 mm Ø 5/16"	No. 6 Ø 9.5 mm Ø 3/8"	No. 7 Ø 11 mm Ø 7/16"	No. 8 Ø 12.5 mm Ø 1/2"	No. 10 Ø 16 mm Ø 5/8"	No. 12 Ø 19 mm Ø 3/4"	Ø 24 mm
--	-----------------------------	------------------------------	-----------------------------	-----------------------------	------------------------------	-----------------------------	-----------------------------	---------

Dysze ceramiczne

H	Standard, Długość=32 mm	14N57 401P101700	14N58 401P101701	14N59 401P101702	14N60 401P101703	14N61 401P101704	-	-	-
J	Jumbo Przepływ lami- nary Długość=48mm	-	-	57N75 401P201451	-	57N74 401P201452	53N88 401P222250	53N87 401P222251	53N89-L 401P222253
K	Jumbo Przepływ lami- nary Długość=34mm	-	-	-	-	-	-	-	53N89 401P222252

Dysza metalowa

L	Standard, Długość=40.7 mm	-	-	86Z01 405P120700	-	86Z02 405P120701	86Z03 405P120702	86Z06 405P120703	-
---	------------------------------	---	---	---------------------	---	---------------------	---------------------	---------------------	---

► = Standard

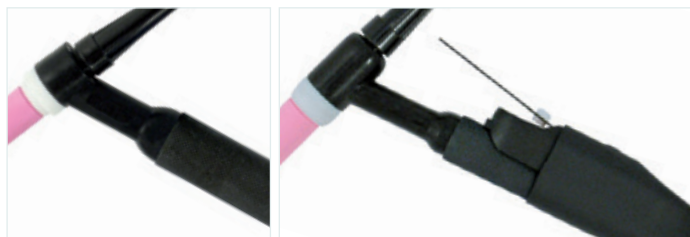

Rękojeści tubowe I mikrowyłączniki

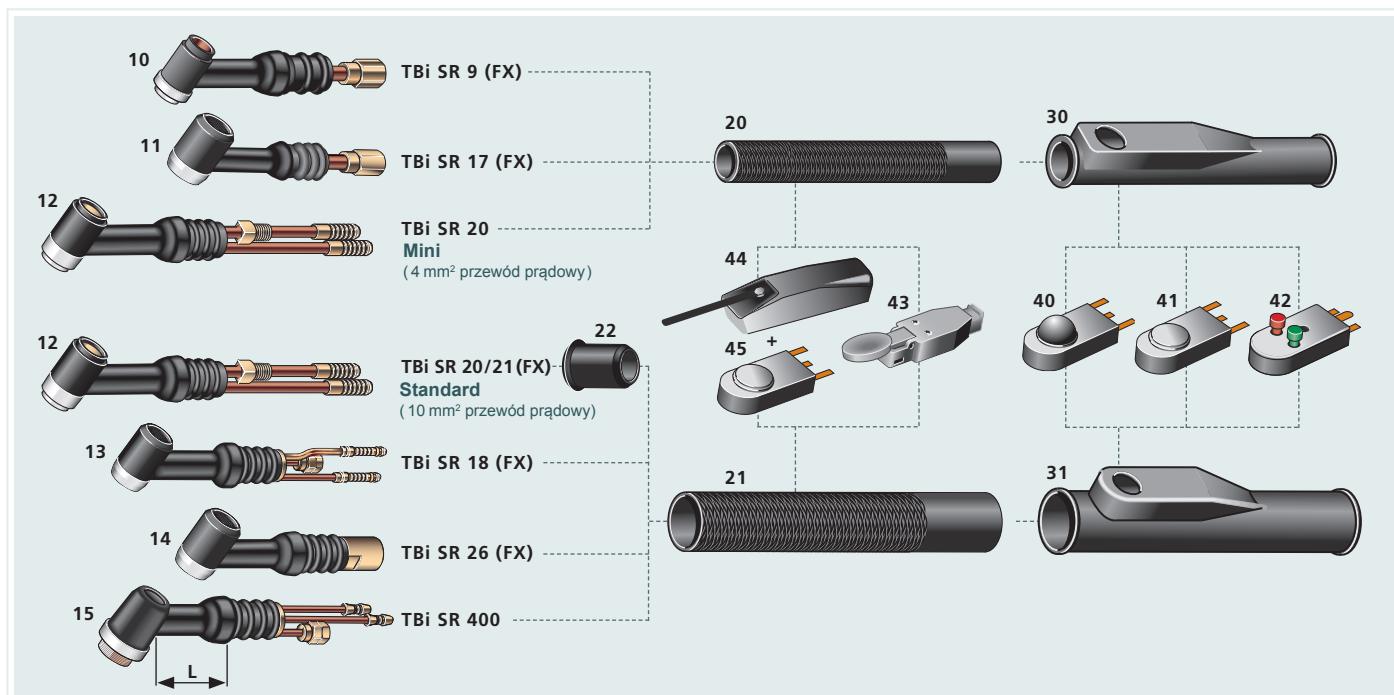

Części zamienne

10	Korpus uchwytu	SR 9		L = 35 mm	405P090800
10	Korpus uchwytu	SR 9 FX	giętki	L = 35 mm	403P090800
11	Korpus uchwytu	SR 17		L = 50 mm	405P170700
11	Korpus uchwytu	SR 17 FX	giętki	L = 50 mm	403P170700
12	Korpus uchwytu	SR 20		L = 35 mm	405P200800
12	Korpus uchwytu	SR 20 FX	giętki	L = 35 mm	403P200700
12	Korpus uchwytu	SR 21		L = 35 mm	405P210800
12	Korpus uchwytu	SR 21 FX	giętki	L = 65 mm	403P210700
12	Korpus uchwytu	SR 21 FX-L	giętki	L = 115 mm	403P210701
13	Korpus uchwytu	SR 18		L = 55 mm	405P180700*
13	Korpus uchwytu	SR 18 FX	giętki	L = 55 mm	403P180700*
14	Korpus uchwytu	SR 26		L = 50 mm	405P260700*
14	Korpus uchwytu	SR 26 FX	giętki	L = 50 mm	403P260700*
15	Korpus uchwytu	SR 400		L = 50 mm	405P400800*

Rękojeść tubowa

20	Rękojeść tubowa	SR 9, SR 17, SR 20 Mini	Ø=20,5 mm / Długość=130 mm	H 100	402P171301
21	Rękojeść tubowa	SR 18, SR 20 Std., SR 26, SR 400	Ø=27,5 mm / Długość=154 mm	H 200	402P180801
22	Tulejka przednia rękojeści	SR 20 Std.			401P201360

Obudowa gumowa mikrowyłącznika

30	Obudowa gumowa mikrowyłącznika	SR 9, SR 17, SR 20 Mini		BS-1	401P170600
31	Obudowa gumowa mikrowyłącznika	SR 18, SR 20 Std., SR 26, SR 400,		BL-1	402P180600

Mikrowyłączniki

40	Mikrowyłącznik	okrągły	SW-1	385P033009
41	Mikrowyłącznik	płaski	SW-1	385P133009
42	Mikrowyłącznik dwufunkcyjny	czerwony, zielony		385P033014
43	Mikrowyłącznik łyżeczkowy			385P120002
44	Mikrowyłącznik łopatkowy			402P101002
45	Mikrowyłącznik typu cruzet	płaski	SW-1	385P233009

* Nie kompatybilne z rękojeścią TBi Precision

Rękojeści



Rekojeści tubowe do korpusów uchwytów z zaworkiem

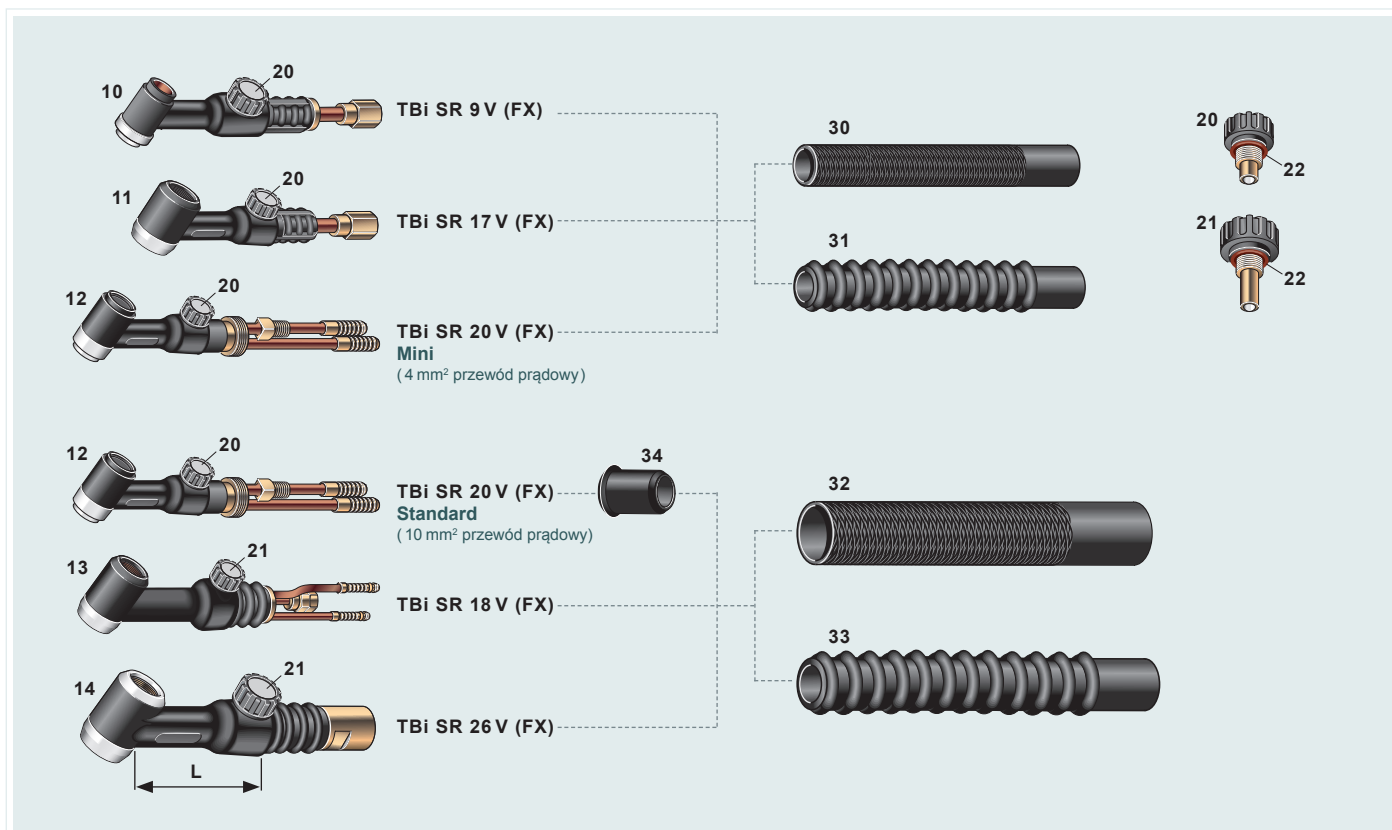

Części zamienne

10	Korpus uchwytu	SR 9 V		L = 50 mm	405P090850
10	Korpus uchwytu	SR 9 V FX	giętki	L = 50 mm	403P090900
11	Korpus uchwytu	SR 17 V		L = 50 mm	405P170800
11	Korpus uchwytu	SR 17 V FX	giętki	L = 50 mm	403P170800
12	Korpus uchwytu	SR 20 V		L = 50 mm	405P200850
12	Korpus uchwytu	SR 20 V FX	giętki	L = 50 mm	403P200900
13	Korpus uchwytu	SR 18 V		L = 70 mm	405P180750
13	Korpus uchwytu	SR 18 V FX	giętki	L = 65 mm	403P180800
14	Korpus uchwytu	SR 26 V		L = 65 mm	405P260800
14	Korpus uchwytu	SR 26 V FX	giętki	L = 65 mm	403P260800
20	Zawór	SR 9 V, SR 17 V, SR 20 V			405P172400
21	Zawór	SR 18 V, SR 26 V			405P262400
22	O-ring (uszczelka)				365P018047

Rękojeść tubowa

▶ 30	Rękojeść gładka	SR 9 V, SR 17 V, SR 20 V Mini	Ø=20,5 mm / Długość=130 mm	H 100	402P171301
▶ 31	Rękojeść prążkowana	SR 9 V, SR 17 V, SR 20 V Mini	Ø=20,5 mm / Długość=130 mm	H 100R	402P179264
▶ 32	Rękojeść gładka	SR 18 V, SR 20 V Std., SR 26 V	Ø=27,5 mm / Długość=154 mm	H 200	402P180801
▶ 33	Rękojeść prążkowana	SR 18 V, SR 20 V Std., SR 26 V	Ø=27,5 mm / Długość=154 mm	H 200R	405P260801
▶ 34	Tulejka przednia Rękojeści	SR 20 V Std.	Ø=21,5 mm / Długość=27 mm		401P201360

Wyposażenie 11-17

▶ = Standard

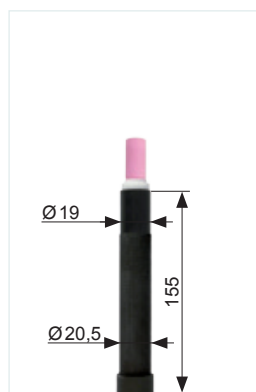

TBi SR 9 P (Aut)

Chłodzenie gazem
60% (10 min.)
AC: 80 A
DC: 110 A
Ø 0.5 - 1.6 mm



TBi SR 18 P (Aut)

Chłodzenie cieczą
100% (10 min.)
AC: 225 A
DC: 320 A
Ø 0.5 - 4.0 mm

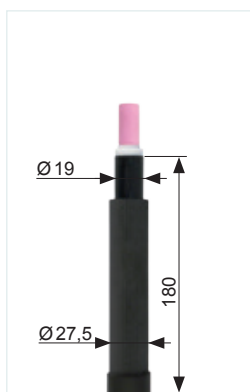

**TBi SR 20 P (Aut)
Standard (10 mm²)**

Chłodzenie cieczą
100% (10 min.)
AC: 160 A
DC: 220 A
Ø 0.5 - 3.2 mm



**TBi SR 20 P (Aut)
Mini (4 mm²)**

Chłodzenie cieczą
100% (10 min.)
AC: 105 A
DC: 140 A
Ø 0.5 - 3.2 mm



TBi SR 26 P (Aut)

Chłodzenie gazem
60% (10 min.)
AC: 170 A
DC: 240 A
Ø 0.5 - 4.0 mm

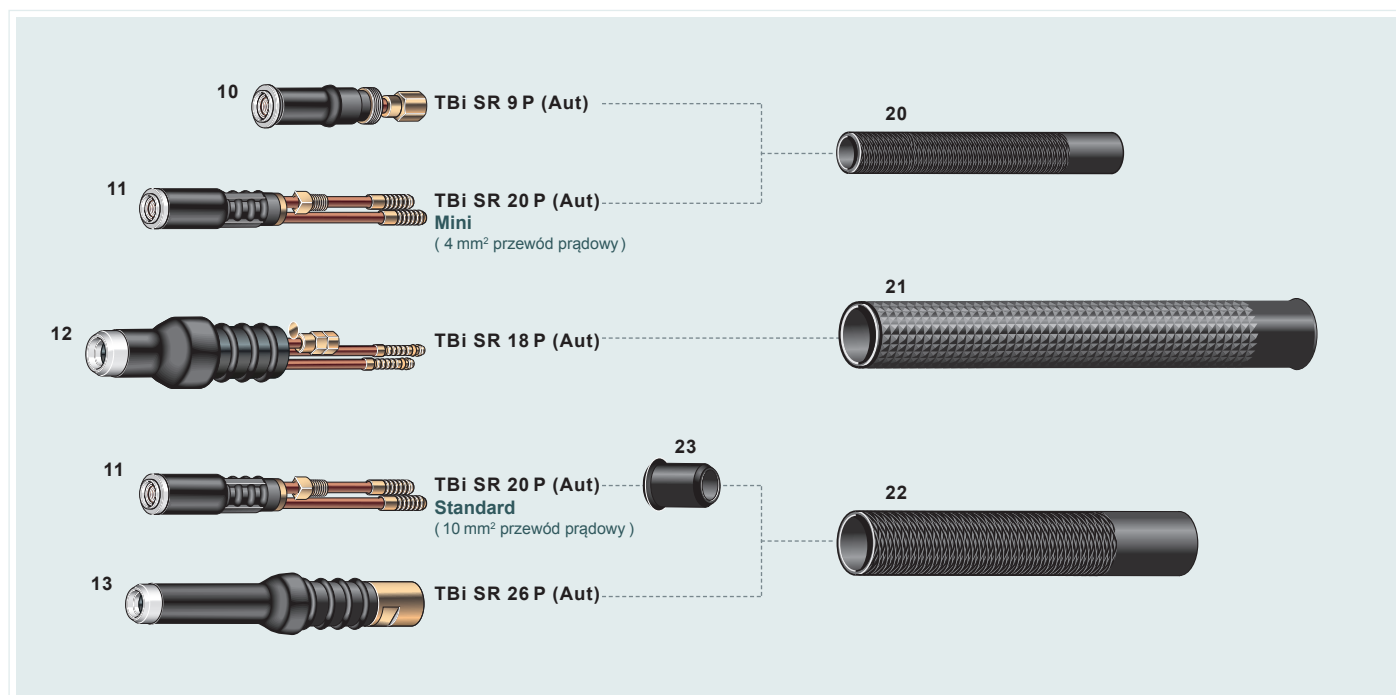

Części zamienne

10	Korpus uchwyty	SR 9 P (Aut)	405P090900
11	Korpus uchwyty	SR 20 P (Aut)	401P200001
12	Korpus uchwyty	SR 18 P (Aut)	491P180001
13	Korpus uchwyty	SR 26 P (Aut)	405P260900

Rękojeść tubowa

▶ 20	Rękojeść tubowa	SR 9 P (Aut), SR 20 P (Aut) Mini	Ø = 20,5 mm / Długość = 130 mm	402P171301
▶ 21	Rękojeść tubowa	SR 18 P (Aut)	Ø = 35 mm / Długość = 250 mm	491P180800
▶ 22	Rękojeść tubowa	SR 26 P (Aut), SR 20 P (Aut) Std.	Ø = 27,5 mm / Długość = 154 mm	402P180801
▶ 23	Tulejka przednia rękojeści	SR 20 P (Aut) Std.	Ø = 21,5 mm / Długość = 27 mm	401P201360

Wyposażenie 11+13

▶ = Standard





Zestaw z częściami szybkozużywającymi się



Zestawy z częściami szybkozużywającymi się do uchwytów spawalniczych TBI TIG



dla
TBi SR 9, TBi SR 20, TBi SR 21

Zawartość zestawów z częściami szybkozużywającymi się

Dla elektrody	Standardowy zestaw dla	Numer katalogowy	 Standard, Długość=30.0 mm	 Standard, Długość=20.6 mm	 Standard, Długość=25.4 mm		
Ø 1.0 mm	-	401P200400	No. 5 Ø 8.0 mm / 5/16"	401P201107	401P201000	401P200600	401P200300
Ø 1.6 mm	TBi SR 9	401P200401	No. 6 Ø 9.5 mm / 3/8"	401P201108	401P201001	401P200601	401P200300
Ø 2.4 mm	TBi SR 20 TBi SR 21	401P200402	No. 7 Ø 11.0 mm / 7/16"	401P201109	401P201002	401P200602	401P200300
Ø 3.2 mm	-	401P200403	No. 8 Ø 12.5 mm / 1/2"	401P201110	401P201003	401P200603	401P200300

dla
TBi SR 17, TBi SR 18, TBi SR 26

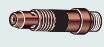
Zawartość zestawów z częściami szybkozużywającymi się

Dla elektrody	Standardowy zestaw dla	Numer katalogowy	 Standard, Długość=47.0 mm	 Standard, Długość=47.0 mm	 Standard, Długość=50.0 mm		
Ø 1.0 mm	-	402P170400	No. 4 Ø 6.5 mm / 1/4"	401P170907	401P180998	402P170500	402P170200
Ø 1.6 mm	TBi SR 17	402P170401	No. 5 Ø 8.0 mm / 5/16"	401P170908	401P180999	402P170502	402P170200
Ø 2.4 mm	TBi SR 18 TBi SR 26	402P170402	No. 6 Ø 9.5 mm / 3/8"	401P170909	401P181000	402P170503	402P170200
Ø 3.2 mm	-	402P170403	No. 7 Ø 11.0 mm / 7/16"	401P170910	401P181001	402P170504	402P170200
Ø 4.0 mm	-	402P170404	No. 8 Ø 12.5 mm / 1/2"	401P170911	401P181002	402P170505	402P170200

Ready for Tomorrow.

© 2015 TBi Industries GmbH. Wszystkie prawa zastrzeżone. Możliwe zmiany bez uprzedzenia. Kopiowanie i przedrukowywanie niedozwolone. Nr. DOKP121019, 04/2015.

TBi Industries GmbH
Ruhberg 14
D-35463 Fernwald-Steinbach
Postfach 67
D-35461 Fernwald-Steinbach

Tel. + 49 6404 9171-0
Fax. + 49 6404 9171-58
Internet: www.tbi-industries.com
E-mail: info@tbi-industries.com